

PRODUCT DESCRIPTION

HNG.248.AZ

Materiali e finitura - *Materials and finishing*

Flangia e perno / *Flange and pin*
acciaio zincato / *steel zinc plated*

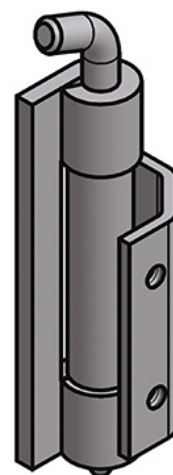
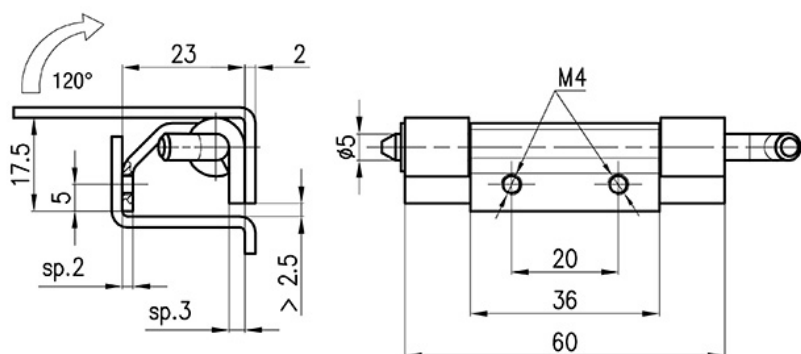

Codice
Part Number
HNG.248.AZ